



Polaris Pro-R, Turbo-R, Pro-XP BantamX Roof Mount Kit (87-0092)



2950 Norman Strasse • San Marcos • CA • 92069

Phone: 661-775-7799 • Fax: 760-560-0383

tech@4x4s-pod.com • www.4x4spod.com



LIMITED LIFETIME WARRANTY

sPOD proudly offers a LIFETIME WARRANTY against manufacturer's defect on all the products that we manufacture.

These are comprehensive warranties; other than the exclusions below – you're covered. If your LED or HID bulb burns out, you're covered. Additionally, cutting off our connector or changing your lenses does not automatically void your warranty.

Exclusions:

Installation errors, abuse, misuse, or crash damage. You must be the original owner of the product and can supply proof of purchase.

sPOD manufactures its own products as well as resells products manufactured by others. sPOD makes no express or implied warranties on products not manufactured by sPOD including without limitation any warranties or merchantability and fitness for a purpose. We will, however, pass on all warranties made by the manufacturer, who has sole responsibility for performing such warranties.

sPOD will pay the freight if your product is less than 90 days old, otherwise defective products must be returned to sPOD, Inc., freight prepaid. At our option, we will repair or replace items in question and return them at no charge. If the identical product is no longer available, we will replace with a similar product of equal value. sPOD Inc. will not be responsible for any indirect or consequential damages in connection with defective merchandise.

Items purchased through a sPOD authorized dealer must be returned through the dealer. Only available on LED auxiliary lights and product must be in sellable condition at MSRP. Product that has been damaged in any way after the original purchase date will be excluded from this guarantee.

Indemnification:

Buyer hereby acknowledges off-roading, racing and driving at night are dangerous activities and that the products and/or supplies purchased from sPOD are used in an inherently dangerous activity that may endanger life and limb; and in no event shall the seller, or seller's heirs and assigns, be held liable for consequential damages, nor shall seller's liability on any claim for damages arising out of or connected with the sale, delivery, or use of purchased products and/or supplies exceed the purchase price of the products and/or supplies.

Buyer is responsible for ensuring that it uses the products (and its vehicle) in accordance with all applicable laws, regulations, guidelines, and standards of care. Buyer acknowledges that some products may only be used when off-roading, and Buyer will comply with all vehicle and road safety guidelines. Buyer is solely responsible for (and will indemnify and hold Bestop harmless for) any claims, losses, damages, fines, fees, costs, or other amounts arising out of Buyer's non-compliance with these provisions.

Tools Required

*T-40 Torx * 7/16", 10mm wrench *Trim removal tool *Phillips head screwdriver

To begin, make sure the vehicle is in park, on level ground and the parking brake is engaged.

1. Attach the PCM to the bracket using a Phillips head screwdriver and the included screws making sure the included gasket is in between the two. Make sure the battery cables are run through the battery cable holes. Route the control cable in through the left slot and plug it into either port.

2. Place two included extruded u-nuts around the two tabs in the passenger footwell (circled).

3. Attach the PCM bracket to the u-nuts using the included $\frac{1}{4}$ "-20 x1/2" hardware and a 7/16" wrench.

4. Using a T40 Torx, remove the passenger side rearward front roof bolt. Place the included zip tie tab between the U-nut and roof and reinstall the bolt.

5. Remove the driver and passenger seats by lifting the latch located at the front of the seat and rocking forward.

6. Using a 10mm wrench, disconnect the negative cables from the batteries. Start by disconnecting battery A's negative cable first (furthest reward battery connection). Some models may have only one battery.

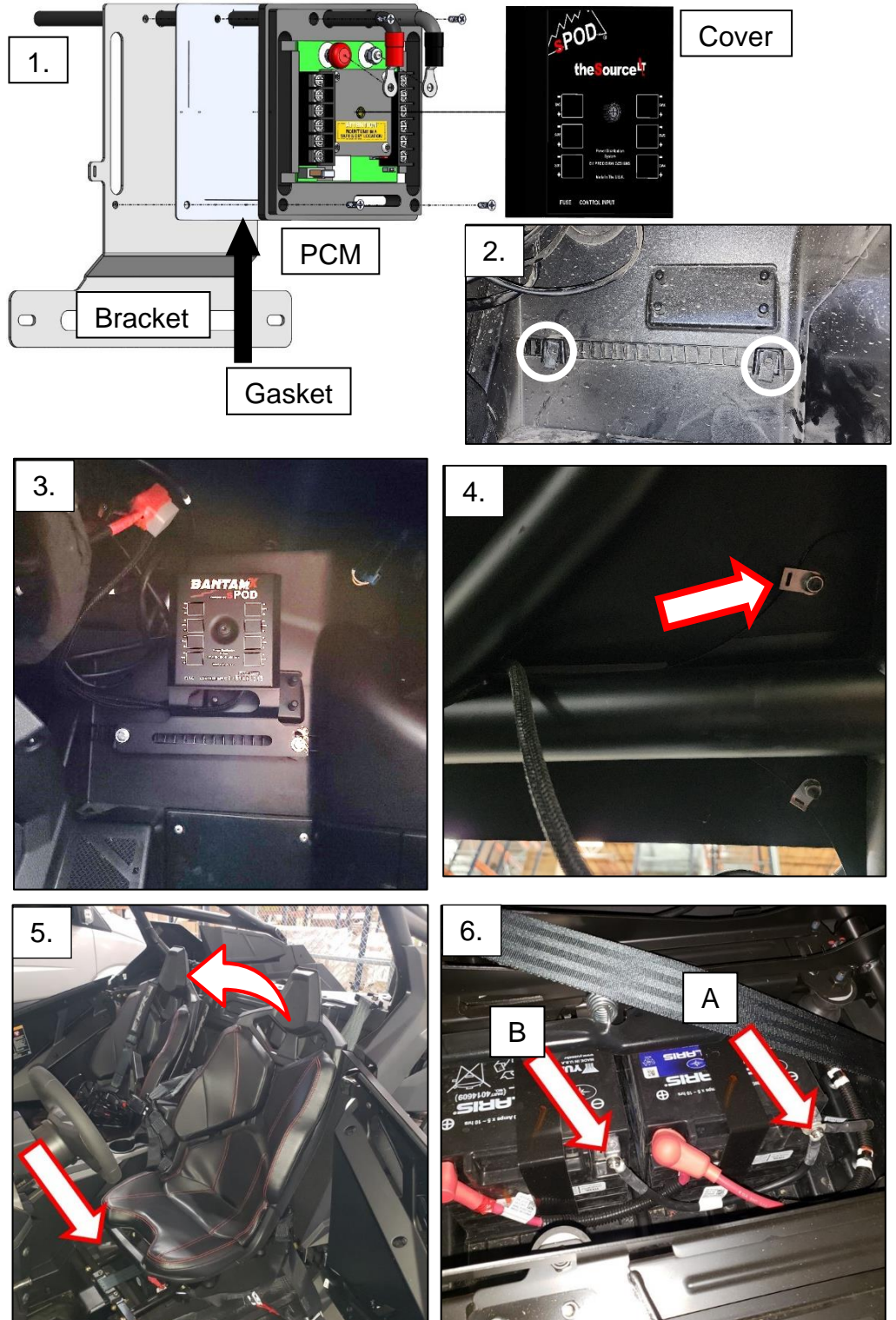

7. Remove the rear upper close-off panel by turning the 4 quarter-turn latches counter-clockwise until they release. Using a trim removal tool, remove the cupholder insert (circled) from the center console.

8. Using the T40 Torx, remove the 4 bolts located near the back of the center console container. Open the center console and turn the 2 quarter-turn fasteners (located near the latch catch) clockwise until they release. Lift up and remove the center console container assembly.

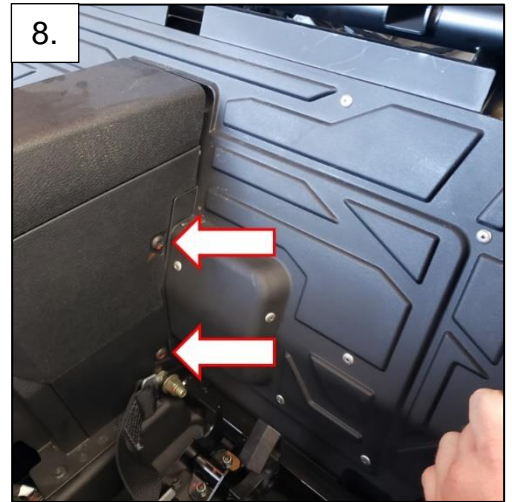
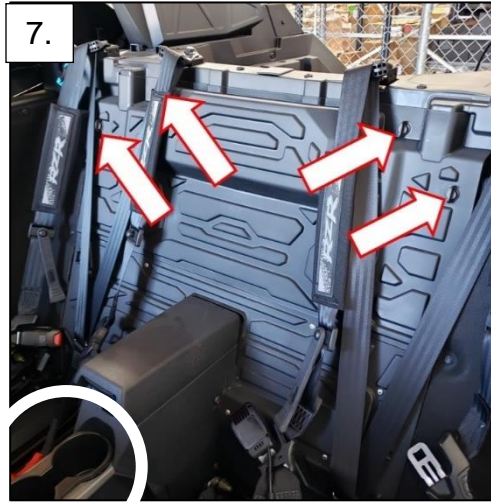

9. Using a trim removal tool or flathead screwdriver, remove the 2 plastic push rivets (one side boxed) behind the cup holders. Using a T40 Torx, remove the 8 bolts (arrowed) securing the passenger side of the center console.

10. Locate and remove the 2 plastic push rivets on the top passenger side center console panel located under the dash.

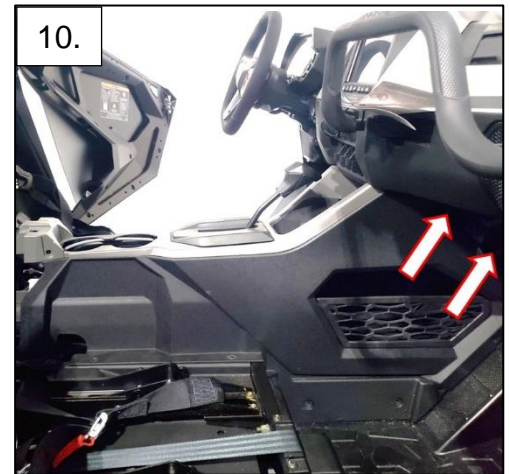
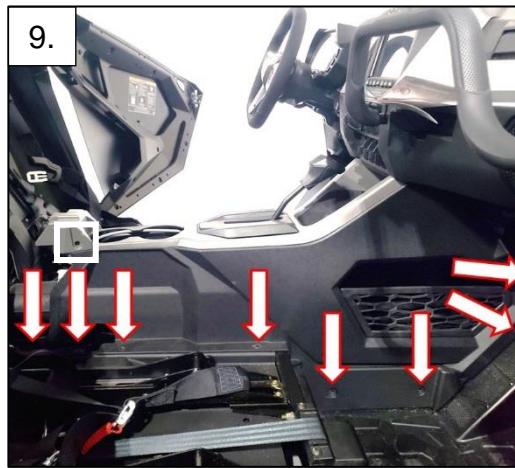

11. Carefully remove the LED on the passenger side center console panel by pressing the plastic trim ring back through the panel.

12. Carefully lift upward on the center panel starting near the back to disengage the retention tabs. Carefully release the passenger side center console panel from the vehicle but leave it near its mounting location.

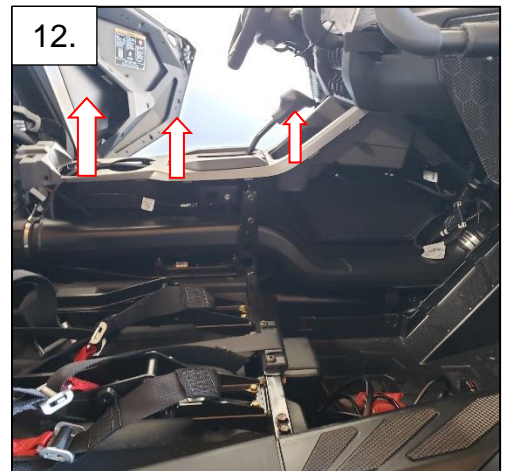
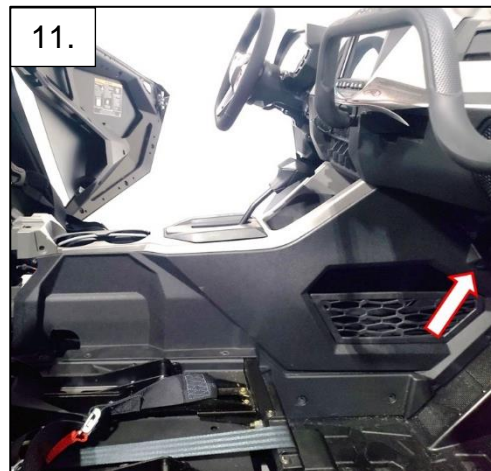

13. Route the power cords from the PCM through the grommet on the front of the center console panel. Run the wires through the center console and to the batteries underneath the driver's seat.

14. Using a 10mm wrench, connect the positive (red) ring terminal to the positive post of the battery. Repeat by connecting the negative (black) ring terminal to the negative post of the battery. If you have 2 batteries. Make sure both negative leads are connected.

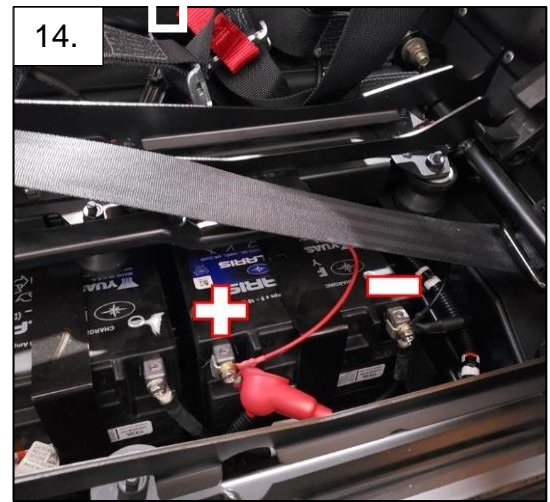

15. Set the passenger side center console panel upright and almost into place. Plug the footwell LED into its mounting hole. Press the panel into place making sure the PCM Power cable wires do not pinch. Insert the two forward push rivets to hold the panel in place.

16. Reinstall the 8 T40 Torx bolts from step 9 and 2 push rivets from step 10.



17. Press the top center console panel into place making sure the retention tabs are properly aligned. Reinstall the push rivets located just behind the cup holders.

18. Reinstall the cupholder insert until the retention tabs engage. Reinstall the center console compartment and secure using the 2 T40 Torx bolts (arrowed) on either side of the console and the quarter-turn fasteners underneath the lid. Make sure the harnesses do not become pinched between any panels.

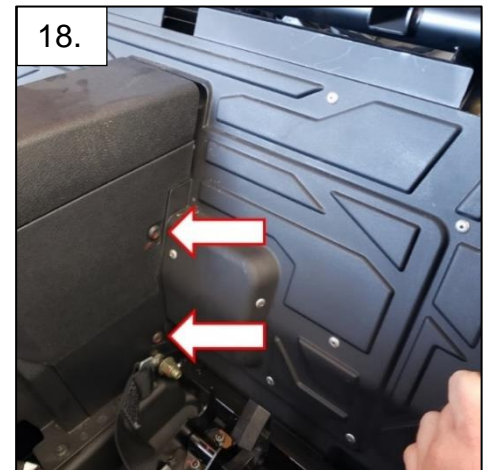
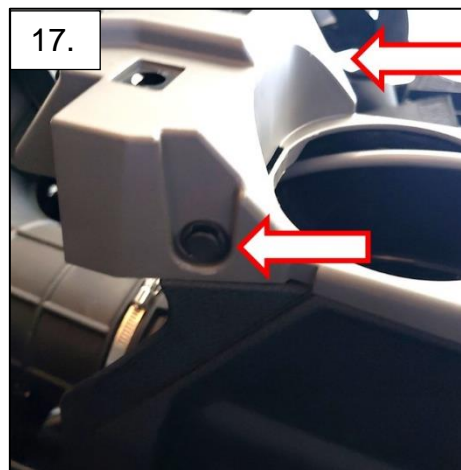

19. Reinstall the upper block-off panel and secure using the 4 quarter-turn latches released in step 7.

20. Reinstall the driver and passenger seats by hooking the front of the seat base and pivoting them into place. Make sure the harnesses do not become stuck behind the seats.



21. Run the control wire from the PCM to the wire passthrough found on the passenger side firewall. Route the wire up the fender well to the base of the roll cage. Make sure to avoid any hot, sharp, rotating or moving components.

22. Fold back the roll cage boot and fish the control wires up through the boot and out the top. Run the wire up the roll cage securing with zip ties around the roll cage and zip tie tab.

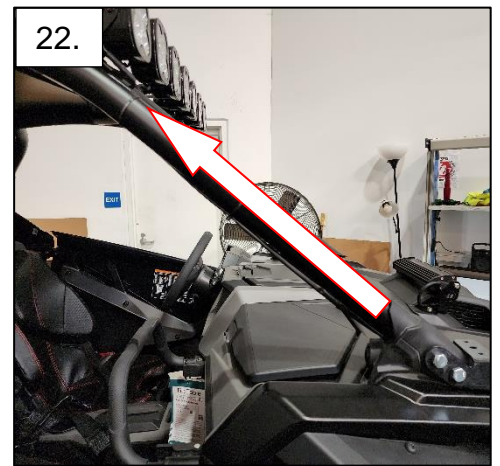
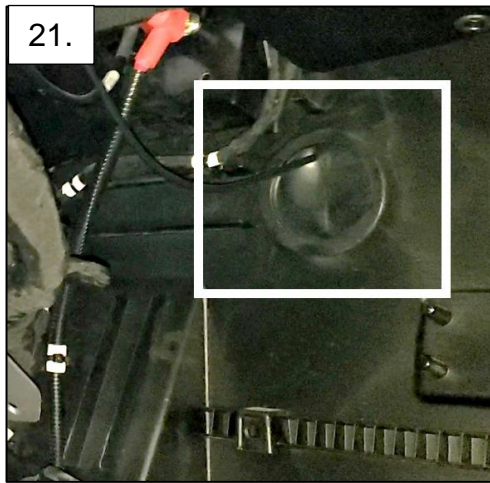

23. Place 2 more extruded u-nuts around the rear-view mirror mounting holes with the threaded end facing the front of the vehicle. Locate the vehicle specific switch mounting bracket and attach it to the vehicle using two 1/4"-20 bolts, washers and a 7/16" wrench. If the vehicle has a rear view mirror, use the 1" long bolt, otherwise use the 5/8"

24. Attach the universal switch mounting bracket to the back of the switch panel using a 10mm wrench (24a). Plug the control wire into the back of the switch panel. With a Phillips head screwdriver, attach the switch panel to the vehicle specific bracket using the 2 included screws

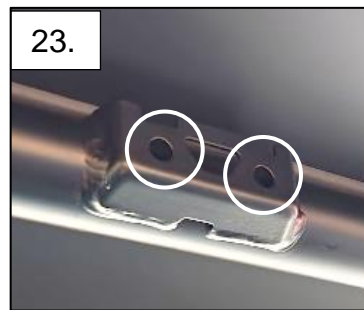

24a.

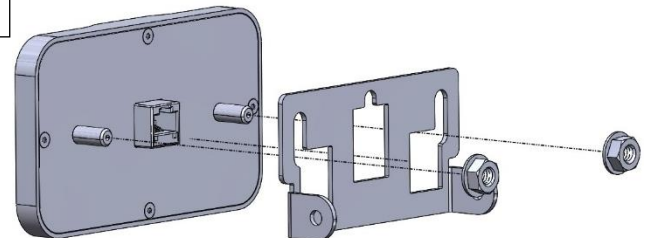

24b.

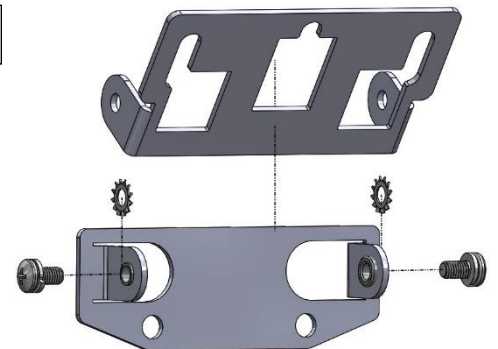

*Tie all wires away from sharp, hot, and/or rotating components.

* Re-torque all the fasteners after 100 miles.

*Your install is now complete! Thank you for choosing Baja Designs.