



**baja designs**<sup>®</sup>  
THE SCIENTISTS OF LIGHTING

**(2004-On) Suzuki DR-Z400/DR-Z400E/DR-Z400S/DR-Z400SM, (1996-On) Suzuki DR-650/DR-650S/DR-650SE Dual S1 Headlight Kit**

**38-7006**



2950 Norman Strasse Rd. • San Marcos • CA • 92069

Phone 760-560-2252x3 • Fax 760-560-0383

info@bajadesigns.com • [www.bajadesigns.com](http://www.bajadesigns.com)



***baja designs***<sup>®</sup>  
THE SCIENTISTS OF LIGHTING

## LIMITED LIFETIME WARRANTY

Baja Designs proudly offers a LIFETIME WARRANTY against manufacturer's defect on all the products that we manufacture.

These are comprehensive warranties; other than the exclusions below – you're covered. If your LED or HID bulb burns out, you're covered. Additionally, cutting off our connector or changing your lenses does not automatically void your warranty.

### **Exclusions:**

Installation errors, abuse, misuse or crash damage. You must be the original owner of the product and can supply proof of purchase.

Baja Designs manufactures its own products as well as resells products manufactured by others. Baja Designs makes no express or implied warranties on products not manufactured by Baja Designs including without limitation any warranties or merchantability and fitness for a purpose. We will, however, pass on all warranties made by the manufacturer, who has sole responsibility for performing such warranties.

Baja Designs will pay the freight if your product is less than 90 days old, otherwise defective products must be returned to Baja Designs, Inc., freight prepaid. At our option, we will repair or replace items in question and return them at no charge. If the identical product is no longer available, we will replace with a similar product of equal value. Baja Designs Inc. will not be responsible for any indirect or consequential damages in connection with defective merchandise.

Items purchased through a Baja Designs authorized dealer must be returned through the dealer. Only available on LED auxiliary lights and product must be in sellable condition at MSRP. Product that has been damaged in any way after the original purchase date will be excluded from this guarantee.

### **Indemnification:**

**Buyer hereby acknowledges off-roading, racing and driving at night are dangerous activities and that the products and/or supplies purchased from Baja Designs are used in an inherently dangerous activity that may endanger life and limb; and in no event shall the seller, or seller's heirs and assigns, be held liable for consequential damages, nor shall seller's liability on any claim for damages arising out of or connected with the sale, delivery, or use of purchased products and/or supplies exceed the purchase price of the products and/or supplies**

## **Tools Required**

\* 10mm, 7/16 socket  
\* 10mm, 7/16 Wrench

\* Phillips head screwdriver  
\* T-10 Torx bit or screwdriver

\* M3 Allen key

1. Turn the ignition off and park the bike on level ground. Using the Phillips head screwdriver, remove the three Phillips head bolts holding the fascia in place. There is two longer bolts on each side and a shorter bolt on the bottom.

2. Using the 10mm socket and 10mm wrench, remove the four 10mm flange bolts on each side. Set these aside as we will reuse them later.

3. Remove the headlight and bracket assembly from the mounting location on the bike. Once out, remove the relay from the headlight bracket by wiggling it off the mounting post. Then, unplug the three pin H4 connector from the headlight on the bike side. You can set the headlight and bracket assembly aside; it won't be needed anymore.

4. Utilizing the T10 torx bit screwdriver, M3 allen key and 7/16 socket and wrench, assemble your S1 lights as shown with the provided S1 hardware.

5. Using the 7/16 socket and wrench, assemble your S1 Lights onto the included vehicle specific bracket. Mount the wide cornering lens S1 on drivers side (D.S.) and mount the spot lens S1 on the passenger side (P.S.) for optimal light functionality.

6. Using the 10mm socket, 10mm wrench, 10mm OEM bolts from the OEM mounting holes, and provided 10mm locknut, assemble the bracket onto the bikes mounting frame, leaving the two top bolts slightly loose on each side. Hold the headlight shell up over the headlight shell mounting holes and angle the bracket until you find the perfect spot where the bracket is flush with the headshell opening. Then, tighten the top two bolts on the bracket.

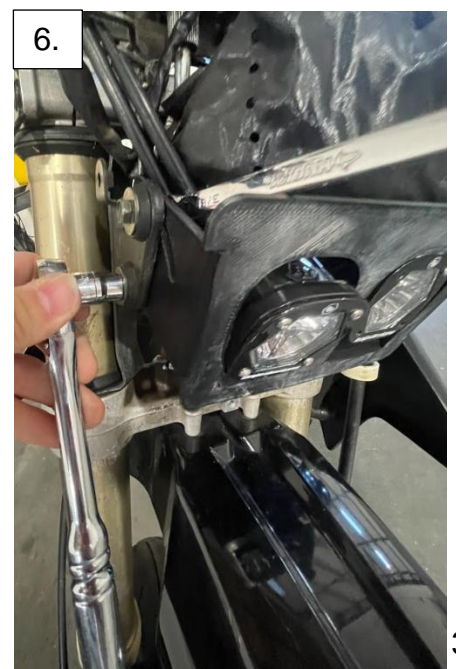
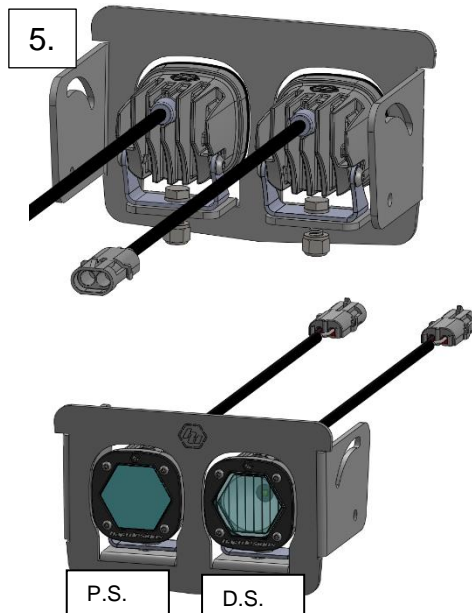
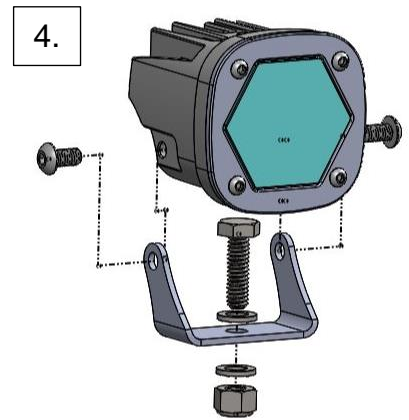
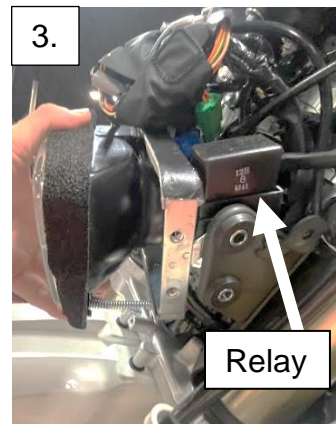
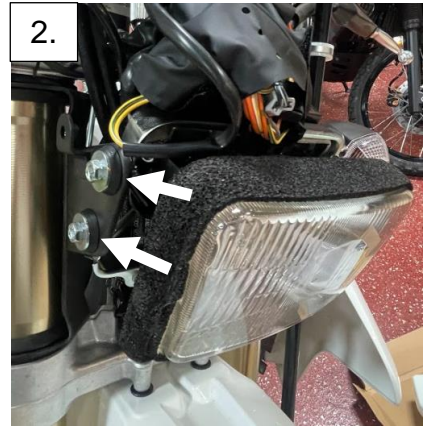
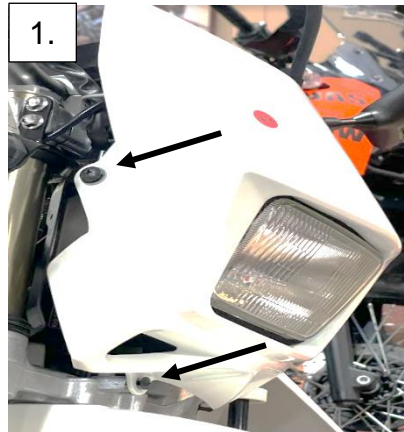



7. Utilizing the provided plug and play wiring adapter, connect the harness into the OEM bike side connector. Plug the drivers side light into the yellow (or white) and black wire plug of the harness, and the passenger side light into the red and black wire plug of the harness. Make sure that the S1 connector locking tabs face the locking dimples on the splitter harness. You will hear a snap when they are properly seated.

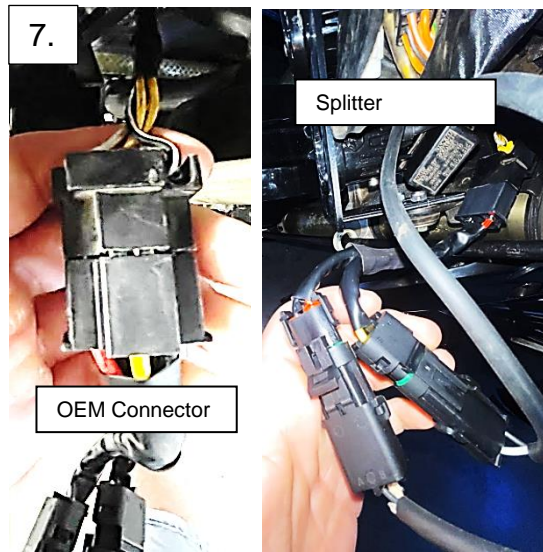

8. Mount your relay and other wiring harnesses back behind the faceplate. Then, replace the headlight shell over the bracket and remount the three Phillips head screws to the frame. Make sure no wires are pinched between the plate and the headlight shell when reinstalled.



\*Tie all wires away from sharp, hot, and/or rotating components.

\* Re-torque all the fasteners after 100 miles.

\*Your install is now complete! Thank you for choosing Baja Designs.