



baja designs[®]
THE SCIENTISTS OF LIGHTING

**KTM 390, 790, 890
S1, Squadron Adventure Bike Kit Instructions**



2950 Norman Strasse Rd • San Marcos • CA • 92069

Phone 760-560-2252 x3 • Fax 760-560-0383

info@bajadesigns.com • www.bajadesigns.com



baja designs[®]
THE SCIENTISTS OF LIGHTING

LIMITED LIFETIME WARRANTY

Baja Designs proudly offers a LIFETIME WARRANTY against manufacturer's defect on all the products that we manufacture.

These are comprehensive warranties; other than the exclusions below – you're covered. If your LED or HID bulb burns out, you're covered. Additionally, cutting off our connector or changing your lenses does not automatically void your warranty.

Exclusions:

Installation errors, abuse, misuse or crash damage. You must be the original owner of the product and can supply proof of purchase.

Baja Designs manufactures its own products as well as resells products manufactured by others. Baja Designs makes no express or implied warranties on products not manufactured by Baja Designs including without limitation any warranties or merchantability and fitness for a purpose. We will, however, pass on all warranties made by the manufacturer, who has sole responsibility for performing such warranties.

Baja Designs will pay the freight if your product is less than 90 days old, otherwise defective products must be returned to Baja Designs, Inc., freight prepaid. At our option, we will repair or replace items in question and return them at no charge. If the identical product is no longer available, we will replace with a similar product of equal value. Baja Designs Inc. will not be responsible for any indirect or consequential damages in connection with defective merchandise.

Items purchased through a Baja Designs authorized dealer must be returned through the dealer. Only available on LED auxiliary lights and product must be in sellable condition at MSRP. Product that has been damaged in any way after the original purchase date will be excluded from this guarantee.

Indemnification:

Buyer hereby acknowledges off-roading, racing and driving at night are dangerous activities and that the products and/or supplies purchased from Baja Designs are used in an inherently dangerous activity that may endanger life and limb; and in no event shall the seller, or seller's heirs and assigns, be held liable for consequential damages, nor shall seller's liability on any claim for damages arising out of or connected with the sale, delivery, or use of purchased products and/or supplies exceed the purchase price of the products and/or supplies.

Buyer is responsible for ensuring that it uses the products (and its vehicle) in accordance with all applicable laws, regulations, guidelines, and standards of care. Buyer acknowledges that some products may only be used when off-roading, and Buyer will comply with all vehicle and road safety guidelines. Buyer is solely responsible for (and will indemnify and hold Bestop harmless for) any claims, losses, damages, fines, fees, costs, or other amounts arising out of Buyer's non-compliance with these provisions.

KTM 390, 790, 890 Squadron/S1 Adventure Bike Kit Instructions

Tools Required

- 7/16" wrench and socket (S1)
- T30 Torx Bit
- 8mm Socket Wrench
- 4mm Allen wrench
- 9/16" wrench and socket (Squadron)

1. Locate the two T30 bolts on the underside of the headlight and the two that hold on the splash guards. Remove bolts and guards.



2. Loosen the two T30 bolts on the rearward side of the crash bars. Do not remove. Remove the bolt on the forward end of the crash bar. Repeat for opposite side of the bike.



3. Slide the bracket over the forward bolt holes from step 3 and thread in the bolts. Use the 4mm Allen wrench to mount the BD Squadron/S1 KTM 790 bracket to the headlight with the provided bolts and washers in the locations from step 1. Replace the splash guards and bolts (Use clearance hole in bracket). Tighten.

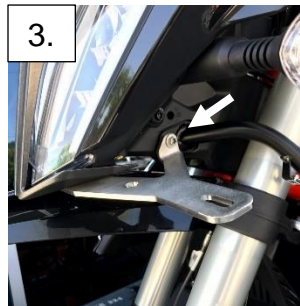

4. Assemble both the lights with the associated hardware using the exploded images for reference. Notice the S1/Squadron bracket orientation. Mount both lights to the bracket shown in step 2.

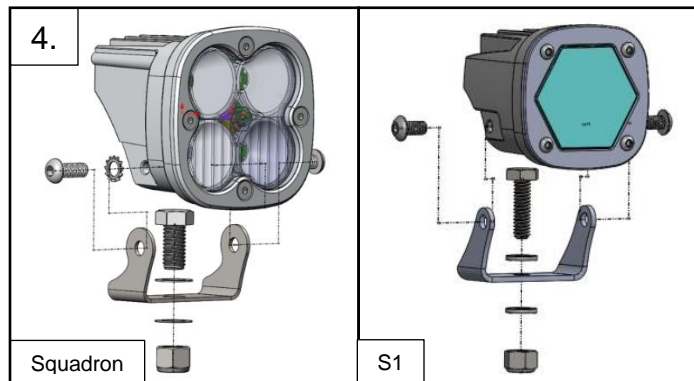

5. Route each light power chord behind the plastic in the starred location. Connect the provided splitter harness near the steering tube.



6. Run the light plug lead of the main wiring harness through the triple clamps next to the steering tube on the left side and connect to the splitter harness from step 4.



7. Route switch lead through the triple clamp and along the arrowed locations and mount the switch to the handlebars with a Philip's screwdriver. Switch can be unplugged from the harness to ease routing.



8. Use the key lock to unlatch and remove the seat. With the T30 bit, remove the two arrowed fasteners on either side of the tank cover, then remove the cover.

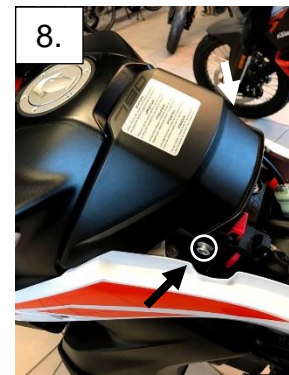

9. Use the T30 Torx bit to remove the four bolts on the left inside radiator fairing.

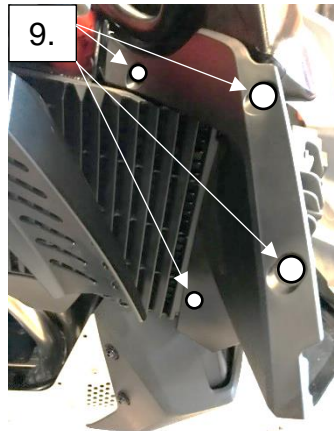

10. Remove the left side rear fairing by pulling near the front edge until the two arrowed dowel pin locations release. Slide rearward to remove.

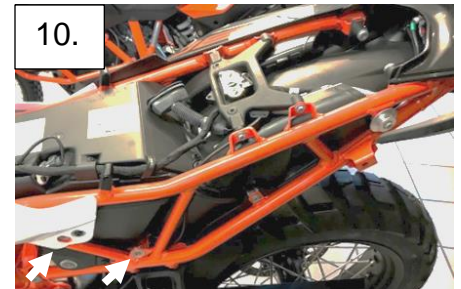

11. Remove the three circled T30 bolts that mount the tank fairing.



12. Route the battery lead of the harness in between the tank and the radiator and then behind the tank fairing. Continue to the battery.

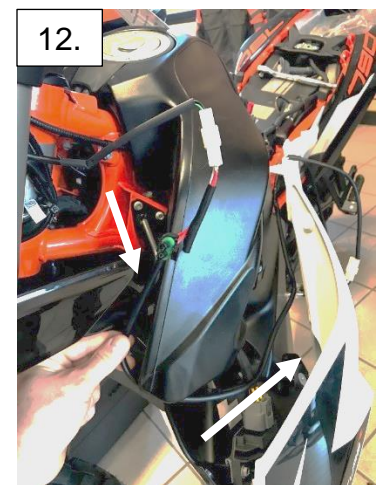

13. Use the 8mm socket wrench to attach the battery leads, positive first. Tie the entire harness away from all hot, sharp, and/or rotating components.

14. Replace the radiator fairing from step 8 then the outer fairing from step 10. Install the rear left side fairing from step 9 and the seat.

15. Using the 7/16" wrench and socket (S1) or 9/16" wrench and socket to loosen, aim, and tighten the lights.

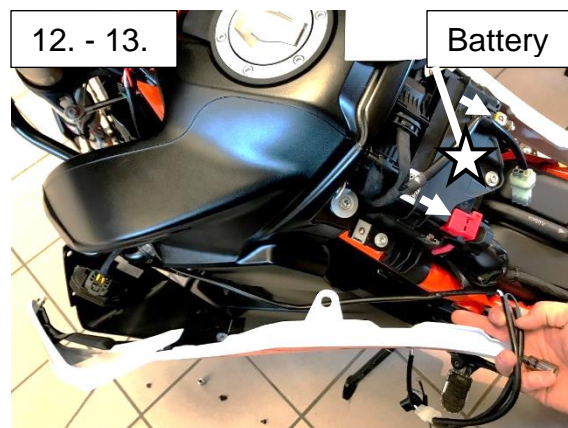

Re-torque all the fasteners after 100 miles.

Your install is now complete! Thank you for choosing Baja Designs.