



**Description:**

Looking for more safety out on the trail? Baja Designs' RTL is your answer. This light features a running light, brake light, amber dust light, and white light and is a must for all enthusiasts looking for extra safety.

**Baja Designs Features:**

**Satisfactions Guarantee** – 30 Day Money Back Guarantee

**Limited Lifetime Warranty** – Complete Purchase Protection

**MoistureBlock™** – Waterproof, Rain Proof, Submersible

**CopperDrive®** – Only LED Driven At 100%

**Specifications:**

**Wattage/Amps:**

**Running Light w/Amber Marker:** 12W

**Brake Light w/Amber Marker:**30W

**White Light:** 18W

**Dimensions:** 32.125" x 2.15" x 1.5"

**Weight:** 3.75 lbs

**LED Life Expectancy:** 49,930 Hours

**Front Lens:** Hard Coated Polycarbonate

**Housing:** Aircraft Grade Aluminum w/Mil-Spec Hard Anodize

**Hardware & Bracket Material:** Stainless Steel

**Exceeds MIL-STD810G (Mil-Spec Testing)**

**Built-In Overvoltage Protection**

**IP69K (Waterproof up to 9ft & Pressure Washable)**

**IK10 Compliant (Mechanical Impact Testing)**

**Includes:**

- RTL, 30" Light Bar
- Mounting Hardware

**Light Features:**

- Running Light
- Brake Light
- White Light
- Amber





**Description:**

The RTL-S comes with integrated flashing amber turn signals for higher visibility and performance off-road. Also featuring a running light, brake light, and white work/cargo light, this bar is a must for all enthusiasts looking for extra safety.

**Baja Designs Features:**

**Satisfactions Guarantee – 30 Day Money Back Guarantee**

**Limited Lifetime Warranty – Complete Purchase Protection**

**MoistureBlock™ – Waterproof, Rain Proof, Submersible**

**CopperDrive® – Only LED Driven At 100%**

**Specifications:**

**Wattage/Amps:**

**Amber Turn Signal (each): 5W / 0.36 amps**

**Running Light: 1.1W / 0.8 amps**

**Brake Light: 20W/ 1.45 amps**

**White Light: 18W/ 1.30 amps**

**Dimensions: 32.125" x 2.15" x 1.5"**

**Weight: 3.75 lbs**

**LED Life Expectancy: 49,930 Hours**

**Front Lens: Hard Coated Polycarbonate**

**Housing: Aircraft Grade Aluminum w/Mil-Spec Hard Anodize**

**Hardware & Bracket Material: Stainless Steel**

**Exceeds MIL-STD810G (Mil-Spec Testing)**

**Built-In Overvoltage Protection**

**IP69K (Waterproof up to 9ft & Pressure Washable)**

**IK10 Compliant (Mechanical Impact Testing)**

**Includes:**

- RTL-S, 30" Light Bar
- Mounting Hardware

**Light Features:**

- Flashing Amber Turn Signals
- Running Light
- Brake Light
- White Light





### Description:

Looking for more safety out on the race course? Baja Designs' RTL-B is your answer. This light features race legal rear taillight specifications and is a must for all drivers looking for that reassurance of being seen when leading the pack.

### Baja Designs Features:

- Satisfactions Guarantee** – 30 Day Money Back Guarantee
- Limited Lifetime Warranty** – Complete Purchase Protection
- MoistureBlock™** – Waterproof, Rain Proof, Submersible
- CopperDrive®** – Only LED Driven At 100%

### Specifications:

- Wattage/Amps:**
- Running Light with Flashing Amber and Solid Amber:** 10W
- Brake Light w/Flashing Amber and Solid Amber:** 28W
- Blue Safety Marker:** 19W
- Dimensions:** 32.125" x 2.15" x 1.5"
- Weight:** 3.75 lbs
- LED Life Expectancy:** 49,930 Hours
- Front Lens:** Hard Coated Polycarbonate
- Housing:** Aircraft Grade Aluminum w/Mil-Spec Hard Anodize
- Hardware & Bracket Material:** Stainless Steel
- Exceeds MIL-STD810G (Mil-Spec Testing)**
- Built-In Overvoltage Protection**
- IP69K (Waterproof up to 9ft & Pressure Washable)**
- IK10 Compliant (Mechanical Impact Testing)**

### Includes:

- RTL-B, 30" Light Bar
- Mounting Hardware

### Lighting Features:

- Running Light
- Brake Light
- Blue Safety Light (Designated for slow moving)





### Description:

Looking for more safety out on the race course? Baja Designs' RTL-G is your answer. This light features race legal rear taillight specifications and is a must for all drivers looking for that reassurance of being seen when leading the pack.

### Baja Designs Features:

**Satisfactions Guarantee** – 30 Day Money Back Guarantee

**Limited Lifetime Warranty** – Complete Purchase Protection

**MoistureBlock™** – Waterproof, Rain Proof, Submersible

**CopperDrive®** – Only LED Driven At 100%

### Specifications:

**Wattage/Amps:**

**Running Light with Flashing Amber and Solid**

**Amber: 10W**

**Brake Light w/Flashing Amber and Solid**

**Amber:28W**

**Green Safety Marker: 19W**

**Dimensions: 32.125" x 2.15" x 1.5"**

**Weight: 3.75 lbs**

**LED Life Expectancy: 49,930 Hours**

**Front Lens: Hard Coated Polycarbonate**

**Housing: Aircraft Grade Aluminum w/Mil-Spec Hard Anodize**

**Hardware & Bracket Material: Stainless Steel**

**Exceeds MIL-STD810G (Mil-Spec Testing)**

**Built-In Overvoltage Protection**

**IP69K (Waterproof up to 9ft & Pressure Washable)**

**IK10 Compliant (Mechanical Impact Testing)**

### Includes:

- RTL-G, 30" Light Bar
- Mounting Hardware

### Lighting Features:

- Running Light
- Brake Light
- Green Safety Light (Designated for slow moving)
- Flashing Amber



RTL-M, Rear Tail Light – Mini, is a miniature version of our existing RTL. At a compact 6-inches this light bar will be exceptionally useful on vehicles where space is limited like Jeeps, motorcycles UTVs or ATVs. We are very excited to bring a new lighting solution to the powersports industry, and look forward to seeing how else the light is utilized.

The RTL-M includes five red LEDs which function as the running and brake lights, a pair of central white LEDs with flood reflectors for area lighting, and a downward facing white LED for license plate illumination.

**Baja Designs Features:**

**Satisfactions Guarantee** – 30 Day Money Back Guarantee

**Limited Lifetime Warranty** – Complete Purchase Protection

**MoistureBlock™** – Waterproof, Rain Proof, Submersible

**CopperDrive®** – Only LED Driven At 100%

**Specifications:**

**Wattage/Amps:**

**Taillight:** 0.75W

**License Plate Light:** 2W

**Brake Light:** 5.5W

**Cargo Light:** 8.5W, 312 Lumens

**Dimensions:** 6.69" x 1.56" x 2.5"

**Weight:** 1.1 lbs

**LED Life Expectancy:** 49,930 Hours

**STANDARDS OF COMPLIANCE**

**Hardware & Bracket Material:** Stainless Steel

**Exceeds MIL-STD810G (Mil-Spec Testing)**

**Built-In Overvoltage Protection**

**IP69K (Waterproof up to 9ft & Pressure Washable)**

**IK10 Compliant (Mechanical Impact Testing)**

**Salt Spray Certified**



**Includes:**

- RTL-M, 6" Light Bar
- Mounting Hardware

**\*Available without License Plate Light\***



Part Number	Description	L inches	W inches	H inches	Weight (lb)	MSRP	
10-0601	RTL-M, 6" Light Bar	6.69	2.15	1.5	1.1	\$249.95	
10-0602	RTL-M, 6" Light Bar, No Plate Light	6.69	2.15	1.5	1.1	\$214.95	
10-3001	RTL-B, 30" Light Bar	32.125	2.15	1.5	3.75	\$424.95	
10-3002	RTL, 30" Light Bar	32.125	2.15	1.5	3.75	\$424.95	
10-3003	RTL-G, 30" Light Bar	32.125	2.15	1.5	3.75	\$424.95	
10-3004	RTL-S, 30" Light Bar	32.125	2.15	1.5	3.75	\$449.95	

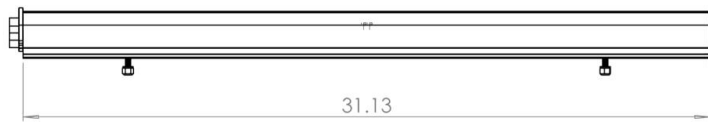
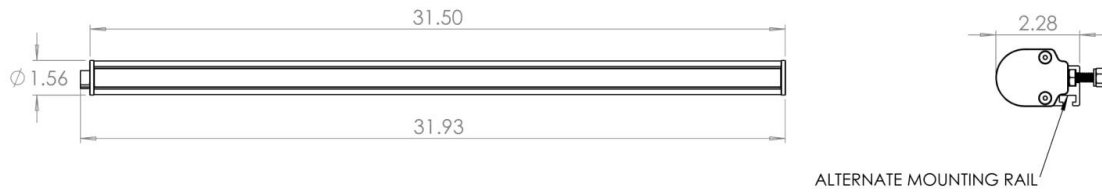

NOTE: MOUNTING HARDWARE CAN BE MOVED TO DESIRED POSITION WITHIN 31.13" SPAN

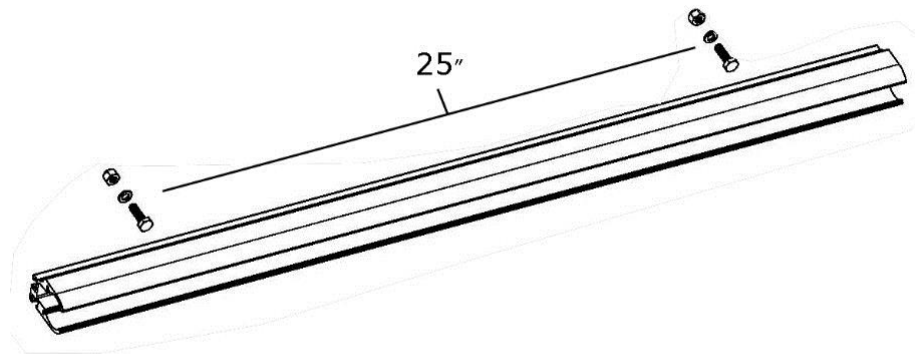

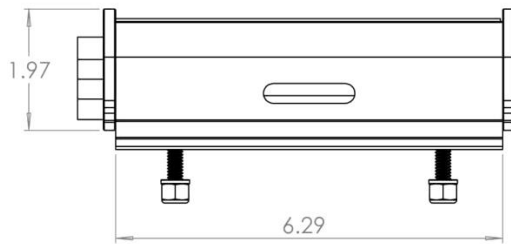
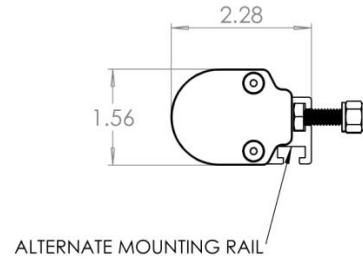
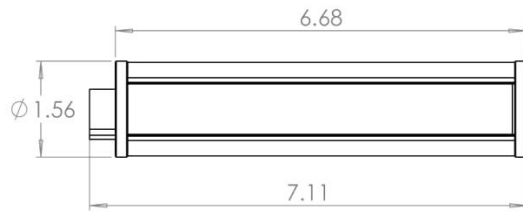

NOTE: MOUNTING HARDWARE CAN BE MOVED TO DESIRED POSITION WITHIN 6.29" SPAN